

CSC60-111

CEILING LUMINAIRE - LED 80W

LUMAX



APPLICATIONS

- * RECREATIONAL CENTERS, HOTELS
- * RESTAURANTS
- * RESIDENTIALS
- * OTHER INDOOR APPLICATIONS WHERE CEILING LUMINAIRE IS REQUIRED

SPECIFICATION FEATURES

- * LAMP : LED 80W
- * SOCKET : N/A
- * SIZE : W600 x 600 x 210 mm
- * MATERIAL : Metal body with Clear and Amber color crystal
- * WEIGHT : 12 Kgs
- * Use remote to switch light color Day, Cool, Warm

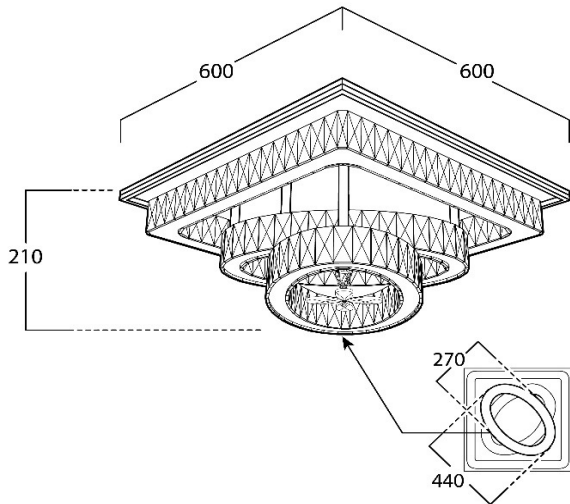

ORDERING DATA

CATALOG NO.	COLOR	LAMP TYPE	REMARKS
CSC60-111 /LED80W			