

PSS35-211/WH

PENDANT LUMINAIRE - GLS 60W /E27x1



LIGHTING &
EQUIPMENT
PUBLIC COMPANY LIMITED



APPLICATIONS

- * RECREATIONAL CENTERS, HOTELS
- * RESTAURANTS
- * RESIDENTIALS
- * OTHER INDOOR APPLICATIONS WHERE
PENDANT LUMINAIRE IS REQUIRED

SPECIFICATION FEATURES

- * LAMP : GLS 60W, GLOBE 60W
- * SOCKET : E27 x 1
- * SIZE : dia 350 x H240 mm (W/O Cable Length)
- * Material : Painted Metal Shade

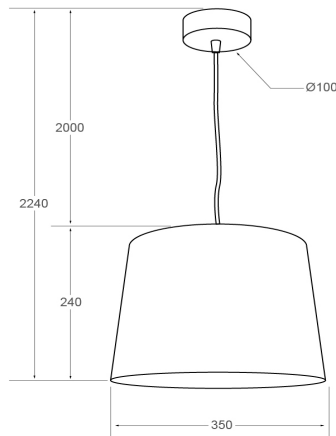

ORDERING DATA

CATALOG NO.	COLOR	LAMP TYPE	REMARKS
PSS35-211/WH/E27x1	WHITE	GLS 60W	