

LED Recessed Downlight



TIS RAL107E

Application

Recessed downlight is designed to use for office buildings, shopping centers, convenience stores, modern trade stores, discount stores, hotels, restaurants, residences, recreation centers, museums, etc.

Specification

Housing	Die-cast aluminium
Finishing	Powder coated in white / black
Mounting	Recessed
Power	14/20/23/30W
Light Source	LED-COB
Colour Temperature	3000/4000/5000K
CRI	>90/ >90/ >80
Lamp Output	14W : 1540/1660/1805 lm 20W : 2200/2370/2575 lm 23W : 2635/2845/3090 lm 30W : 3500/3770/4015 lm
Luminaire Output	14W : 1342/1449/1570 lm* 20W : 1854/2002/2169 lm* 23W : 2135/2305/2497 lm* 30W : 2914/3147/3351 lm*
Beam Angle	15/24/36/60 Degree
Control Gear	Separate driver
Power Supply	220-240VAC, 50Hz
Power Factor	>0.9
Insulation Class	I
IP Rating	20
Luminaire Lifetime	40,000 hrs
Equivalent	14W : PAR30 75W 20W : MH 20W 23W : MH 35W 30W : MH 70W
Remarks	*Value at 24 Degree

Ordering Data

Model	Watt
RAL107E/WH-14LED	14W
RAL107E/WH-20LED	20W
RAL107E/WH-23LED	23W
RAL107E/WH-30LED	30W

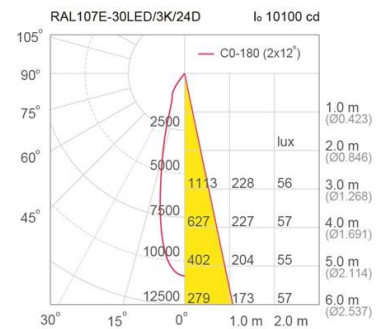
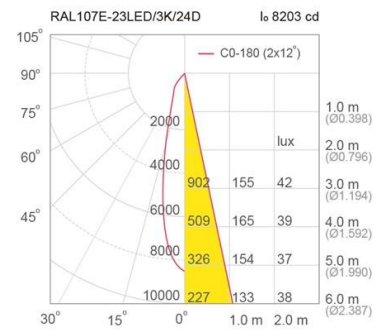
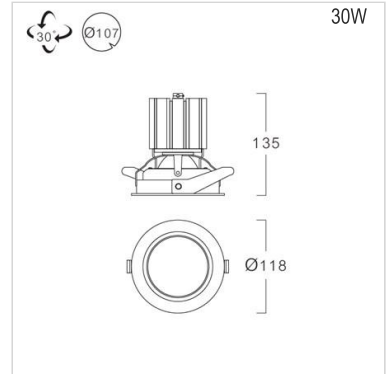
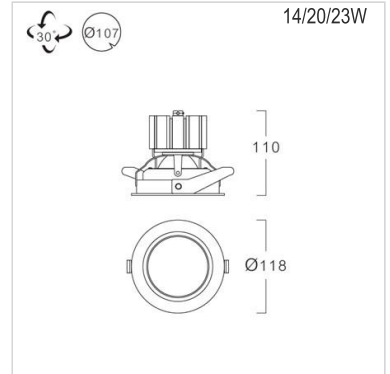
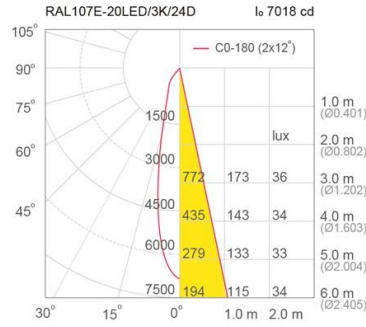
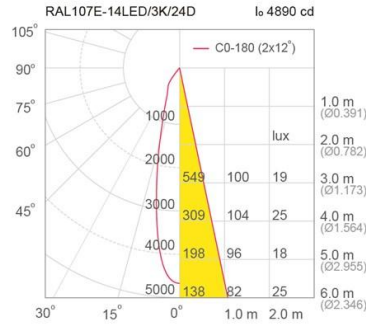

Related Products



14W

20W

15D

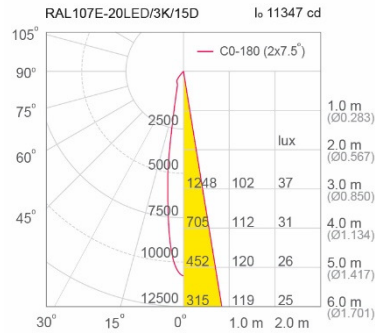
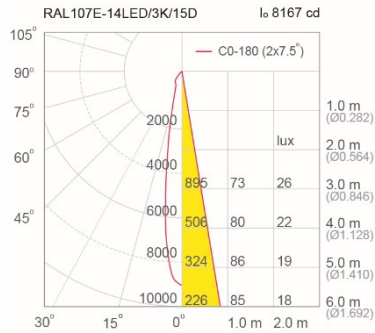

24D

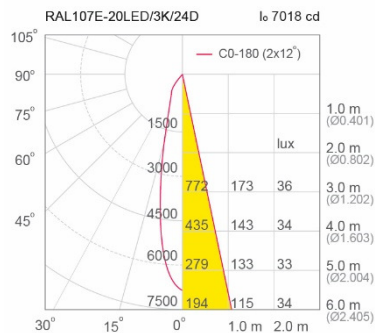
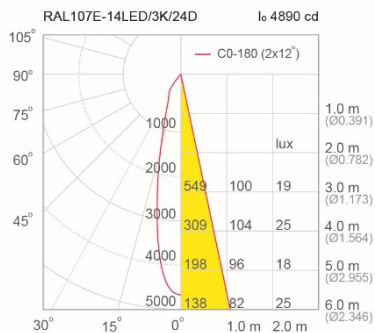

36D

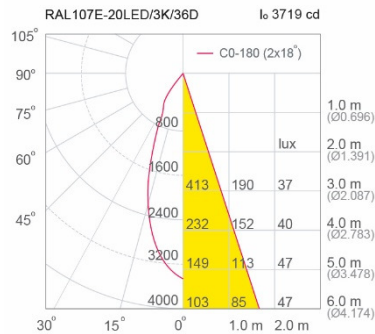
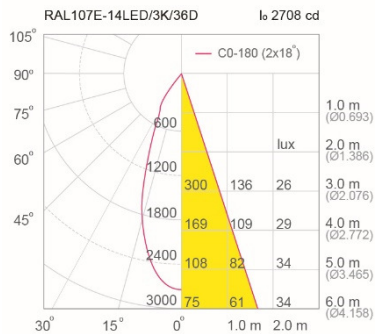

60D

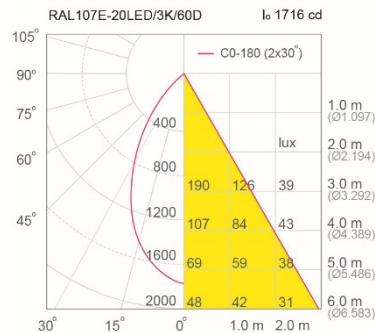
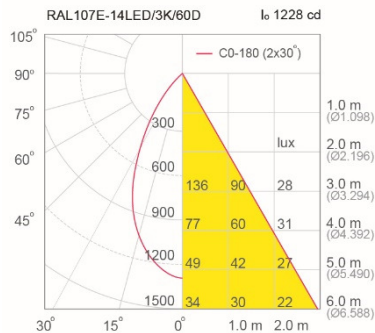

23W

30W

15D

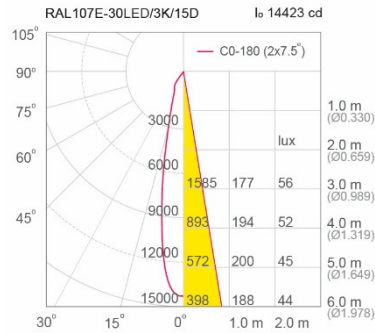
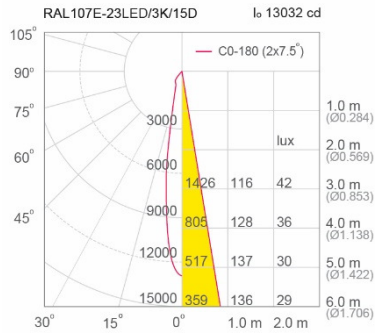

24D

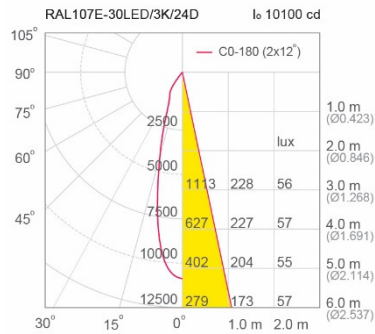
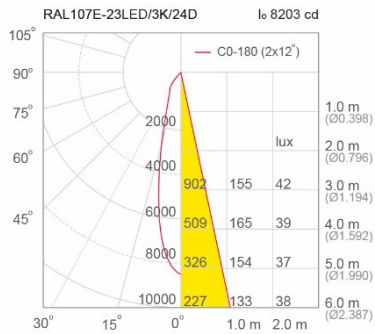

36D

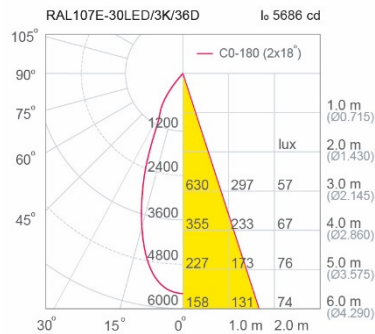
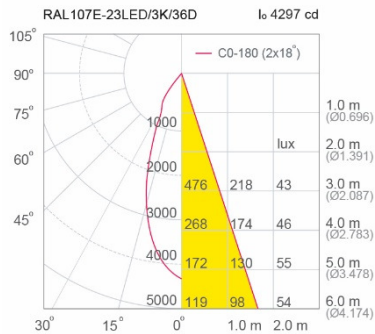

60D

