

LED Recessed Downlight



TIS RAL107D/E

Application

Recessed downlight is designed to use for office buildings, shopping centers, convenience stores, modern trade stores, discount stores, hotels, restaurants, residences, recreation centers, museums, etc.

Specification

Housing	Die-cast aluminium
Finishing	Powder coated in white / black
Mounting	Recessed
Power	14/20/23/30W
Light Source	LED-COB
Colour Temperature	3000/4000/5000K
CRI	>90/ >90/ >80
Lamp Output	14W : 1540/1660/1805 lm 20W : 2200/2370/2575 lm 23W : 2635/2845/3090 lm 30W : 3500/3770/4015 lm
Luminaire Output	14W : 1342/1449/1570 lm* 20W : 1854/2002/2169 lm* 23W : 2135/2305/2497 lm* 30W : 2914/3147/3351 lm*
Beam Angle	15/24/36/60 Degree
Control Gear	Separate driver
Power Supply	220-240VAC, 50Hz
Power Factor	>0.9
Insulation Class	I
IP Rating	20
Luminaire Lifetime	40,000 hrs
Equivalent	14W : PAR30 75W 20W : MH 20W 23W : MH 35W 30W : MH 70W
Remarks	*Value at 24 Degree

Ordering Data

Model	Watt
RAL107D/E/WH-14LED	14W
RAL107D/E/WH-20LED	20W
RAL107D/E/WH-23LED	23W
RAL107D/E/WH-30LED	30W

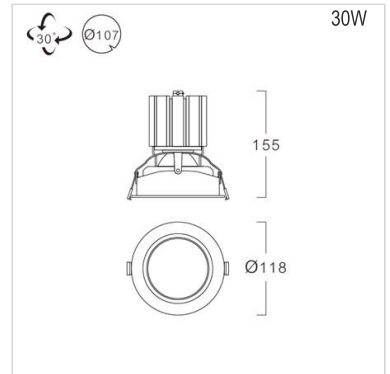
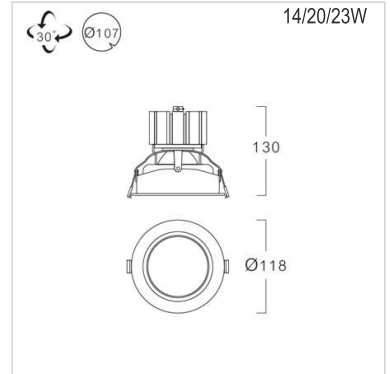
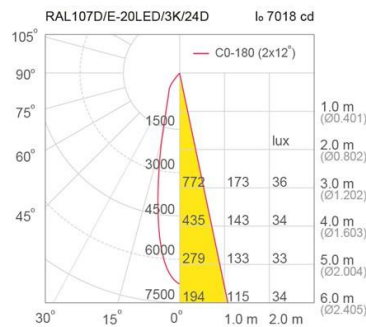
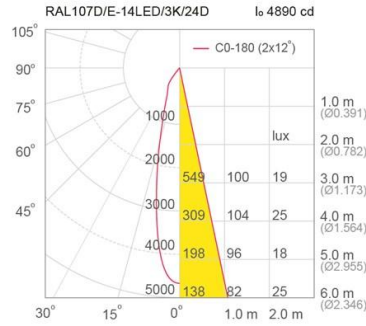

Related Products

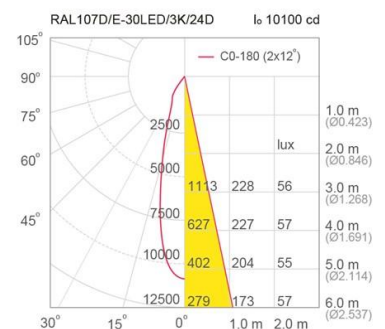
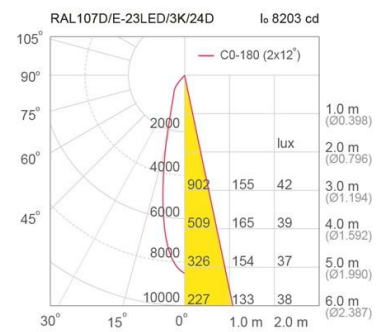

14W

20W

15D

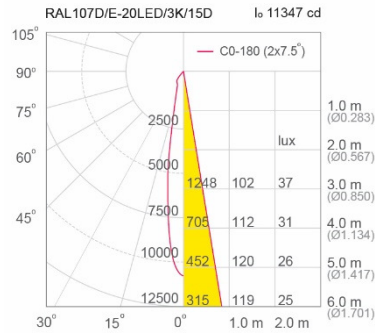
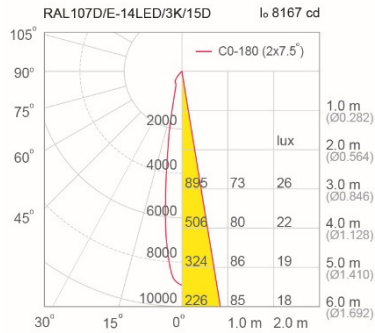

24D

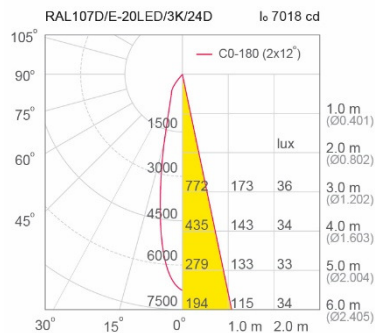
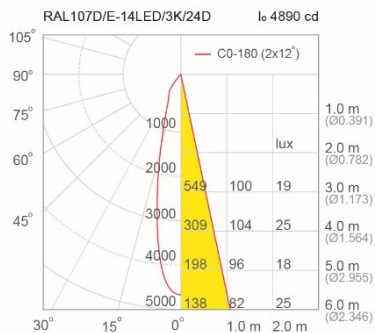

36D

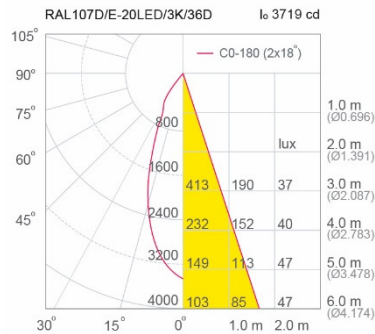
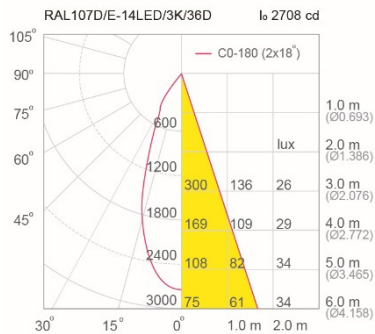

60D

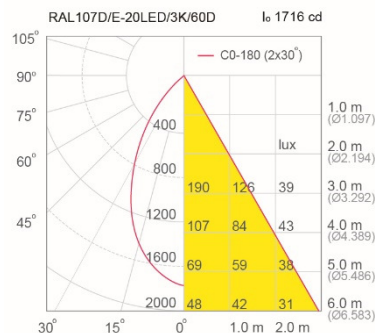
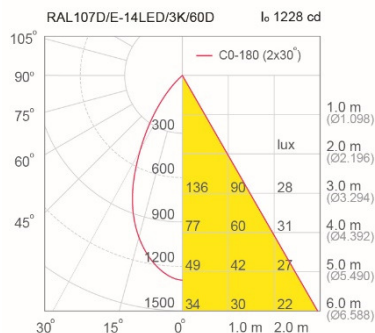

23W

30W

15D

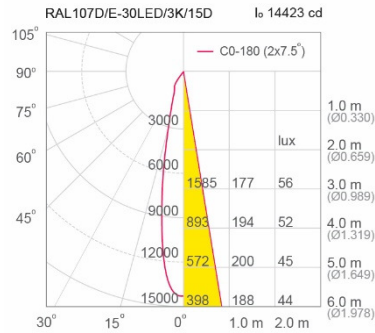
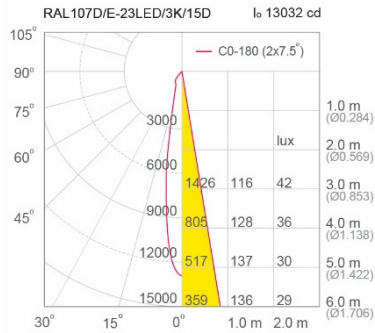

24D

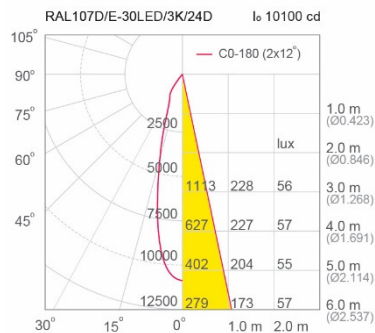
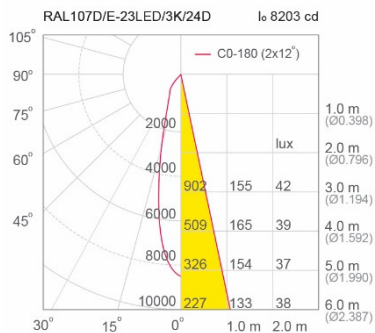

36D

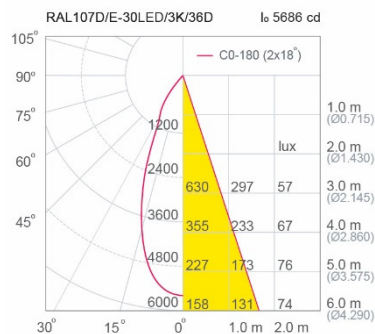
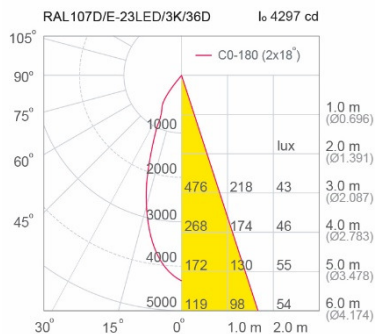

60D

